

CATALOGO PRODOTTI ITALIA

in vigore da MARZO 2025

SMONTAGOMME

E ACCESSORI ORIGINALI



SICE
AUTOMOTIVE EQUIPMENT

ED. MAGGIO 2025

TABELLA COLORI

Standard		RAL 1007	Giallo	A => /40
Optional		RAL 3002	Rosso	B => /16
Optional		RAL 5015	Blue	C => /25
Optional		RAL 9006	Grigio chiaro	D => /36

Il telaio principale é sempre grigio scuro RAL 7016 

NEXION S.p.A. declina ogni responsabilità per eventuali reclami derivanti dall'utilizzo di accessori o ricambi non originali con conseguente decadenza della dichiarazione di conformità CE.

SMONTAGOMME TRADIZIONALI SEMI-AUTOMATICI	4	SMONTAGOMME CAMION "LEVER-LESS"	64
M39 ATV PER RUOTE MOTO	4	S 58LL	64
ACCESSORI PER SMONTAGOMME DA MOTO M39 ATV	5		
S 41 E CROSS	7	SMONTAGOMME CAMION PER IL SERVIZIO MOBILE	65
ACCESSORI PER S 41 E CROSS	8	S 50A MOBILE	65
S 41 E	10	S 50 MOBILE	66
S 41 E MAXI	11	ACCESSORI PER SMONTAGOMME CAMION	67
SMONTAGOMME TRADIZIONALI AUTOMATICI	12		
S 42 E	12		
S 43 - S 43 A	13		
S 45 BASIC	14		
S 45	15		
S 45 TOP	16		
SMONTAGOMME VETTURA PER IL SERVIZIO MOBILE	17		
S 44 M	17		
ACCESSORI PER SMONTAGOMME VETTURA TRADIZIONALI	18		
SMONTAGOMME VETTURA "LEVERLESS"	33		
S 45 TL	33		
S 45 TL TOP	34		
S 48 TL TOP	35		
S 200	36		
S 200 A	37		
SERIE S 300	38		
S 1000 EVOLUZIONE S.L.	39		
S 1000 EVOLUZIONE P.L.	40		
S 1000 EVOLUZIONE A P.L.	41		
ACCESSORI PER SMONTAGOMME VETTURA "LEVERLESS"	42		
SMONTAGOMME CAMION SEMI-AUTOMATICI	56		
S 52 A	56		
S 53	57		
S 54	58		
S 54 A	59		
S 560 M	60		
S 55 - S 55A	61		
S 560 EVO	62		
S 60	63		

M39 ATV PER RUOTE MOTO

Dotazione

x4 456533

x8 442019C

x4 GK
cod. 8-11600123

x1 PPM
cod. 8-11600020

x1 LPK
cod. 8-11400098



ULM
cod. 30095168









Codice	Alimentazione	Descrizione
0-11613501/34	230V / 1Ph / 50Hz	M39 ATV Grigio RAL 7016

ACCESSORI PER SMONTAGOMME DA MOTO M39 ATV

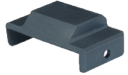
Immagine	Descrizione	Codice	
<p>x6</p> 	<p>PPM Kit 6 protezioni paletta moto.</p>	<p>8-11600020</p>	
	<p>SR Kit appoggio ruote.</p>	<p>8-11600116</p>	
	<p>PR Kit rullo montaggio ruote.</p>	<p>8-11600117</p>	
	<p>UCA Kit 4 griffe cross.</p>	<p>8-11600118</p>	
<p>x4</p> 	<p>ATV A Kit adattatori ATV.</p>	<p>8-11600119</p>	
	<p>ATV C Kit centraggio ruote ATV.</p>	<p>8-11600120</p>	

ACCESSORI PER SMONTAGOMME DA MOTO M39 ATV

Immagine	Descrizione	Codice	
	<p>CKM Kit 4 griffe di bloccaggio.</p>	8-11600121	
<p>x4</p> 	<p>GKS Kit protezioni in plastica.</p>	8-11600122	
<p>x4</p> 	<p>GK Kit 4 adattatori GO-KART.</p>	8-11600123	
	<p>Portaoggetti smontagomme moto.</p>	8-11600124	
	<p>Secchiello con grasso 1 Kg.</p>	8-11600125	
	<p>IG.P pistola di gonfiaggio, omologata CE</p>	8-11600126	

S 41 E CROSS

Dotazione

x5  cod. 8-11100107

x10  cod. 8-11100106



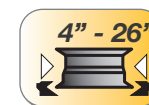
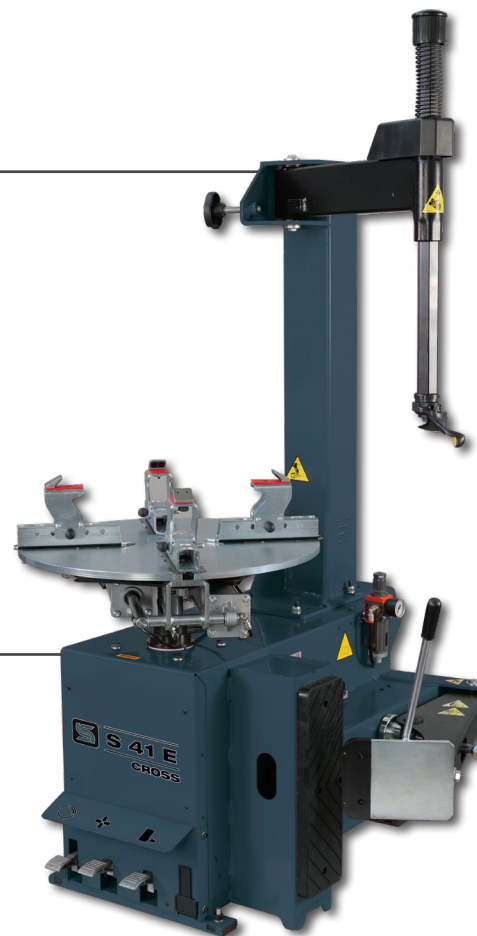

cod. 8-11600126

cod. 4-405308









Codice	Alimentazione	Descrizione	
0-11481101/34	400V/3Ph/50Hz	S 41 E CROSS	
0-11481102/34	230V/3Ph/50Hz	S 41 E CROSS	
0-11481103/34	230V/1Ph/50Hz	S 41 E CROSS	

ACCESSORI PER S 41 E CROSS

Immagine	Descrizione	Codice	
	<p>Kit griffe autocentrante moto racing 8"-26"</p>	8-11100461	
	<p>Kit griffe autocentrante ATV 5"-18"</p>	8-11100462	
	<p>Piattaforma removibile per ruota moto</p>	8-11100463	
	<p>Helper BPL</p>	8-11120032	

ACCESSORI PER S 41 E CROSS

Immagine	Descrizione	Codice	
	Kit 5 inserti inferiori in plastica per torretta	8-11100107	
	Kit 10 inserti frontali in plastica per torretta	8-11100106	
	TPA-W kit torretta in plastica solo per S41E e S42E	8-11400334	
	TPA-W torretta in plastica singola	8-11400330	
	TMN Torretta per ruote scooter. Completa di protezioni in plastica per cerchi in lega. A partire da Matricola SRC197168	8-11100378	
	TMN Torretta per ruote scooter Fino a Matricola SRC197167	801252083	

S 41 E

Dotazione

x5



cod. 8-11100107

x10



cod. 8-11100106



cod. 8-11600126

cod. 4-405308



Codice	Alimentazione	Descrizione	
0-11472001/34	400V/3Ph/50Hz	S 41 E	
0-11472002/34	200-230V/1Ph/50Hz	S 41 E	
0-11472012/34	200-230V/1Ph/60Hz	S 41 E	
0-11473001/34	400V/3Ph/50Hz	S 41 E GP	
0-11473002/34	200-230V/1Ph/50Hz	S 41 E GP	
0-11472006/34	12 Volt	S 41 E 12V	
0-11472005/34	AIR MOTOR	S 41 E Air Motor	

S 41 E MAXI

Dotazione

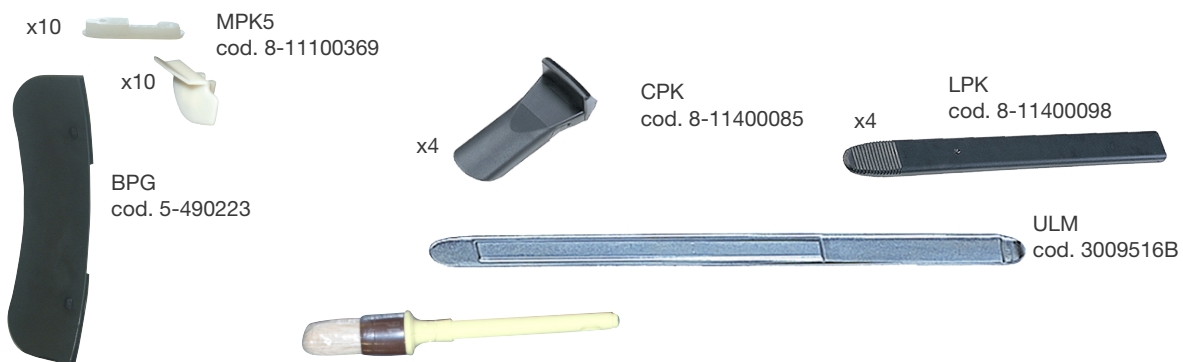

Codice	Alimentazione	Descrizione
0-11461124/40	230V/1ph/50-60Hz	S 41E Maxi (dispositivo FPI incluso)

S 42 E

Dotazione

x5  cod. 8-11100107

x10  cod. 8-11100106



cod. 8-11600126

cod. 4-405308

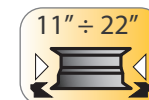
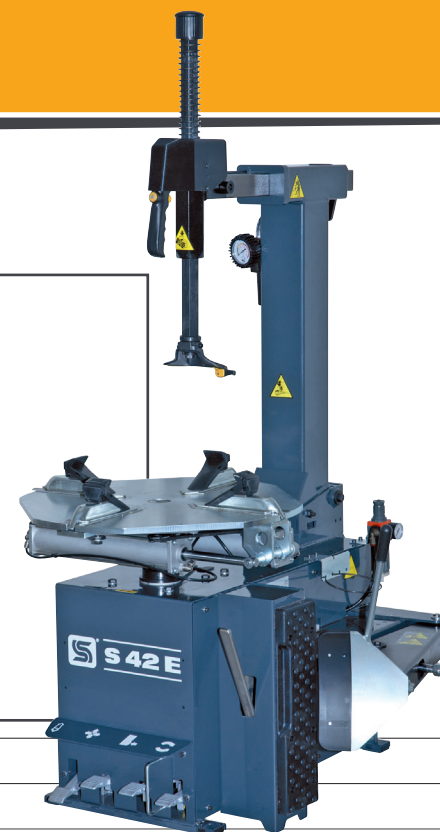
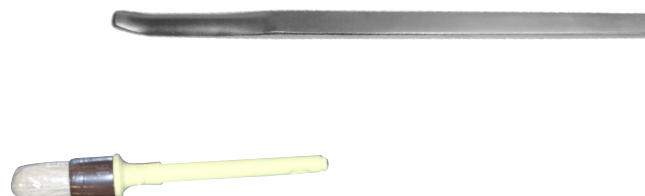

Codice	Alimentazione	Descrizione
0-11474401/34	400V/3ph/50Hz	S42E 22"
0-11474402/34	230V/1ph/50Hz	S42E 22"
0-11474411/34	200-230V/3ph/60Hz	S42E 22"
0-11474412/34	230V/1ph/60Hz	S42E 22"
0-11474432/34	INV. 230/1ph/50-60Hz	S42E 22" 2V
0-11474441/34	2V 400/3ph/50Hz	S42E 22" 2V
0-11474451/34	2V 200-230V/3ph/60Hz	S42E 22" 2V
0-11474201/34	400V/3ph/50Hz	S42E 22" GP
0-11474202/34	230V/1ph/50Hz	S42E 22" GP
0-11474211/34	200-230V/3ph/60Hz	S42E 22" GP
0-11474212/34	230V/1ph/60Hz	S42E 22" GP
0-11474232/34	INV. 230/1ph/50-60Hz	S42E 22" GP 2V
0-11474241/34	2V 400/3ph/50Hz	S42E 22" GP 2V
0-11474251/34	2V 200-230V/3ph/60Hz	S42E 22" GP 2V

S 43 - S 43 A

Dotazione



BPG
cod. 5-490223

x10



MPK5
cod. 8-11100369

x10



x4



CPK
cod. 8-11400085

x3



REP
cod. 8-11120014



ULM
cod. 3009516B

x4



LPK
cod. 8-11400098



Codice	Alimentazione	Descrizione	
0-11463039/40	INV. 230V/1Ph/50-60Hz	S 43 24"	
0-11463132/40	INV. 230V/1Ph/50-60Hz	S 43 24" GP (dispositivo FPI incluso)	
0-11463134/40	INV.230V/1ph/50-60Hz	S43 A 24"	
0-11463135/40	INV.230V/1ph/50-60Hz	S43 A 24" GP (dispositivo FPI incluso)	

S 45 BASIC

Dotazione



Codice	Alimentazione	Descrizione	
0-11464010/AA	2V 400V/3Ph/50Hz	S 45 Basic RAL 1007	
0-11464010/BA	2V 400V/3Ph/50Hz	S 45 Basic RAL 3002	
0-11464010/CA	2V 400V/3Ph/50Hz	S 45 Basic RAL 5015	
0-11464112/AA	2V 400V/3Ph/50Hz	S 45 Basic GP RAL 1007	
0-11464112/BA	2V 400V/3Ph/50Hz	S 45 Basic GP RAL 3002	
0-11464112/CA	2V 400V/3Ph/50Hz	S 45 Basic GP RAL 5015	

S 45

Dotazione

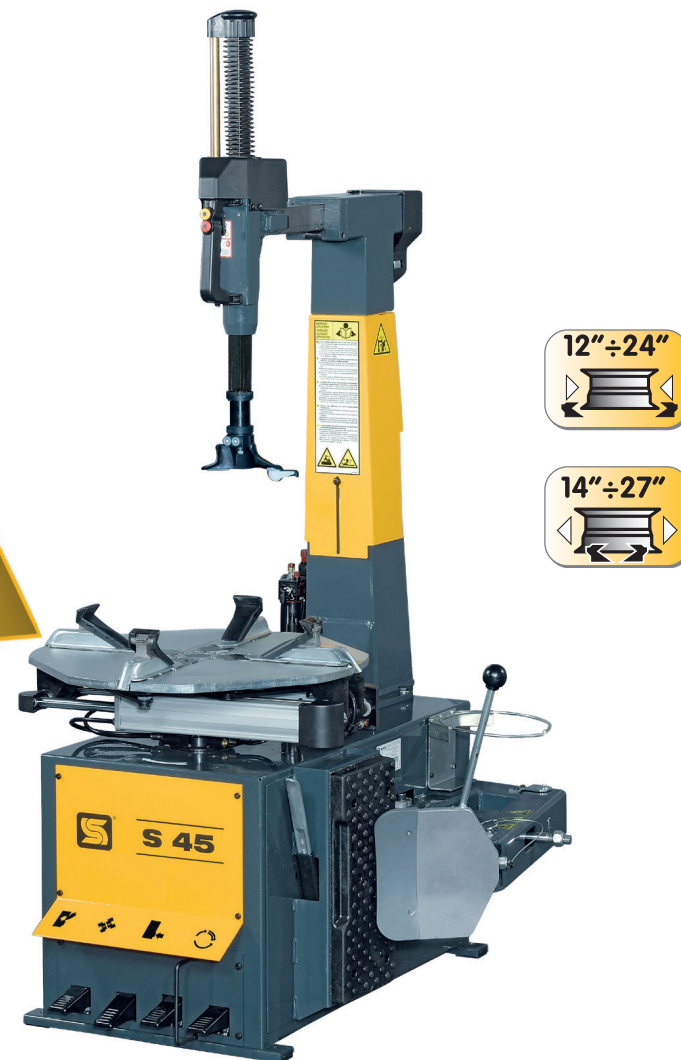
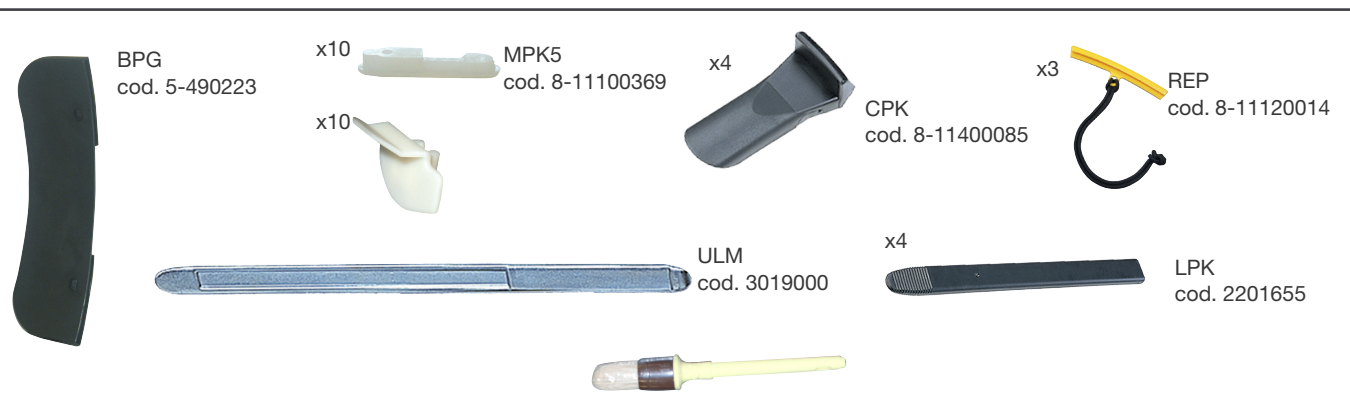

Codice	Alimentazione	Descrizione
0-11464025/40	INV.230V/1ph/50-60Hz	S 45 24"
0-11464115/40	INV.230V/1ph/50-60Hz	S 45 24" GP (dispositivo FPI incluso)

S 45 TOP



07/007

Dotazione



Codice	Alimentazione	Descrizione	
0-11464023/00	INV. 230/1ph/50-60Hz	S45 TOP con BPT ribaltabile (PT250 incluso)	
0-11464114/00	INV. 230/1ph/50-60Hz	S45 TOP GP con BPT ribaltabile (PT250 incluso)	

S 44 M



PER IL SERVIZIO MOBILE

HELPER BPL
a richiesta

Dotazione

bpg
cod. 5-490223



x4

x10

Consigliati

premi tallone helper sx
cod. 8-11100399 - pbl
kit di connessione
cod 8-11320005



pinza premi tallone
rft e wdk
cod. 801262417











pinza premi tallone
cod. 80143685





Codice	Alimentazione	Descrizione
0-11481001/40	12V	S44 MOBILE Dx 24" 12V

ACCESSORI PER SMONTAGOMME VETTURA TRADIZIONALI

Immagine	Descrizione	Codice	S 41 E	S 41 Maxi	S 41 E Maxi	S 42	S 42 E	S 43 - S 43Gp 24"	S 45 Basic	S 45 - S 45Gp	S 45 TOP	S 44 M
SISTEMA CONTROLLO SENSORI												
	TPM-02 Dispositivo portatile per il controllo dei sensori TPMS.	6015001300	0	0	0	0	0	0	0	0	0	0
	Kit OBD (cavo + card reader).	8-64500013	0	0	0	0	0	0	0	0	0	0
	TPM-02 PLUS (include kit OBD)	6015001391	0	0	0	0	0	0	0	0	0	0
   	Abbonamento 12M TPM-02 standard	8-51100029										
	Abbonamento 12M TPM-02 extended	8-51120003	0	0	0	0	0	0	0	0	0	0
	Abbonamento 12M TPM-02 PLUS	8-51120001										
	Abbonamento 12M TPM-02 PLUS extended	8-51120004										
IMMAGINE NON DISPONIBILE	Servizio opzionale di installazione strumento.	8-51120006	0	0	0	0	0	0	0	0	0	0
	Stampante Bluetooth.	6015001360	0	0	0	0	0	0	0	0	0	0

ACCESSORI PER SMONTAGOMME VETTURA TRADIZIONALI

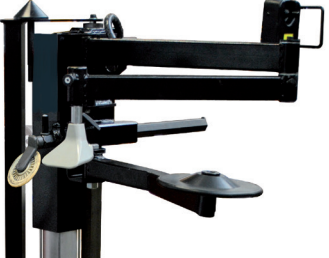
Immagine	Descrizione	Codice		S 41 E	S 41 Maxi	S 41 E Maxi	S 42	S 42 E	S 43 - S 43Gp	S 45 Basic	S 45 - S 45Gp	S 45 TOP	S 44 M
ACCESSORI COMPLEMENTARI - DISPOSITIVO ALZA-PREMI TALLONE													
	PT 150E Dispositivo alza-premi tallone.	8-11100410		-	-	-	O	-	O	O	O	-	-
	BPL Helper SX	8-11120032		O	-	O	-	O	-	-	-	-	
	Kit connessione BPL	8-11100399		-	-	-	-	-	-	-	-	-	O
	Kit completo PT230 versione a disco (S42 e S43), montante incluso	8-11320005		-	-	-	O	-	O	-	-	-	-
		8-11400332		-	-	-	O	-	O	-	-	-	-





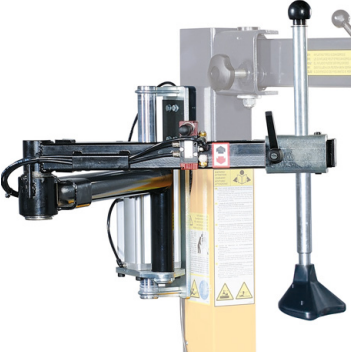

ACCESSORI PER SMONTAGOMME VETTURA TRADIZIONALI

Immagine	Descrizione	Codice		S 41 E	S 41 Maxi	S 41 E Maxi	S 42	S 42 E	S 43 - S 43Gp	S 45 Basic	S 45 - S 45Gp	S 45 TOP	S 44 M
ACCESSORI COMPLEMENTARI - DISPOSITIVO ALZA-PREMI TALLONE													
	Kit completo PT230 versione standard a rullo (S42 e S43), montante incluso	8-11400333		-	-	-	O	-	O	-	-	-	-
	Kit completo PT230E versione standard a rullo (S42E), montante incluso	8-11400335		-	-	-	-	O	-	-	-	-	-
	Kit cono premi-cerchio.	8-11100311		-	-	-	O	-	O	-	-	-	-
	Kit estensioni per premi-cerchio.	8-11100153		-	-	-	O	-	O	-	-	-	-
	PT 250 - Dispositivo alza-premi tallone. Da Installare In Loco	8-11400139		-	-	-	O	-	O	O	O	-	-
	PT 250 - Dispositivo alza-premi tallone. Pre-Installato In Azienda	8-11400140		-	-	-	O	-	O	O	O	●	-

ACCESSORI PER SMONTAGOMME VETTURA TRADIZIONALI

Immagine	Descrizione	Codice		S 41 E	S 41 Maxi	S 41 E Maxi	S 42	S 42 E	S 43 - S 43Gp	S 45 Basic	S 45 - S 45Gp	S 45 TOP	S 44 M
ACCESSORI COMPLEMENTARI - DISPOSITIVO ALZA-PREMI TALLONE													
	<p>PT 40 - Dispositivo alza-premi tallone. Da Installare In Loco</p>	8-11400215		-	O	-	-	-	-	-	-	-	-
	<p>PT 50 Helper multifunzione.</p>	8-11100343		-	-	-	O	O	O	-	-	-	-
	<p>Kit di montaggio e personalizzazione.</p>	8-11100364		-	-	-	O	-	O	-	-	-	-
	<p>Kit di montaggio e personalizzazione per S 42 E.</p>	8-11400331		-	-	-	-	O	-	-	-	-	-
	<p>KIT da rullo a disco per HELPER 8-11100343</p>	8-11120096		-	-	-	O	O	O	-	-	-	-







ACCESSORI PER SMONTAGOMME VETTURA TRADIZIONALI

Immagine	Descrizione	Codice		S 41 E	S 41 Maxi	S 41 E Maxi	S 42	S 42 E	S 43 - S 43Gp	S 45 Basic	S 45 - S 45Gp	S 45 TOP	S44 M
ADATTATORI AUTOCENTRANTE													
 x4	AR10 Serie di adattatori per ridurre la capacità di bloccaggio esterno di 4".	8-11100043		-	O	O	O	-	O	O	O	O	-
 x4	AR24 Serie di adattatori per aumentare la capacità di bloccaggio esterno di 4".	8-11100041		-	O	O	O	O	O	O	O	O	O
 x4	AR69 Serie di adattatori per ridurre la capacità di bloccaggio esterno di 4".	8-11100042		O	O	O	O	O	O	O	O	O	O
 x4	AR46 Serie di adattatori per aumentare la capacità di bloccaggio esterno di -7"/+5".	8-11400276		-	O	O	O	-	O	O	O	O	-
 x4	ARM Kit di adattatori moto.	8-11100036		O	O	O	O	O	O	O	O	O	O
 x4	ARM-BD Kit di adattatori moto.	2201113A		O	O	O	O	O	O	O	O	O	O









ACCESSORI PER SMONTAGOMME VETTURA TRADIZIONALI

Immagine	Descrizione	Codice		S 41 E	S 41 Maxi	S 41 E Maxi	S 42	S 42 E	S 43 - S 43Gp	S 45 Basic	S 45 - S 45Gp	S 45 TOP	S44 M
ADATTATORI AUTOCENTRANTE													
	DBU26 Dispositivo di bloccaggio universale per ruote di scooter, go-kart, moto e Harley Davidson.	8-11400100		O	O	O	O	O	O	O	O	O	O





ACCESSORI PER SMONTAGOMME VETTURA TRADIZIONALI

Immagine	Descrizione	Codice	S 41 E	S 41 Maxi	S 41 E Maxi	S 42	S 42 E	S 43 - S 43Gp	S 45 Basic	S 45 - S 45Gp	S 45 TOP	S 44 M
CONSUMABILI												
	∅											
 x4	BPG Serie di protezioni in plastica grigia di ricambio per nuova paletta stallonatrice, prodotta da ottobre 2004.	5-490223	-	●	●	●	-	●	●	●	●	-
 x6	Kit di 6 protezioni paletta nere	801258383	O	-	-	-	O	-	-	-	-	O
IMMAGINE NON DISPONIBILE	Kit di 6 protezioni leva nere	801246241	-	-	-	-	O	-	-	-	-	-
 x5	Kit 5 inserti inferiori in plastica per torretta	8-11100107	O	-	-	-	O	-	-	-	-	-
 x10	Kit 10 inserti frontali in plastica per torretta	8-11100106	O	-	-	-	O	-	-	-	-	-
 x20	OPK Serie di protezioni in plastica di ricambio per torretta.	2201199	-	O	O	O	-	O	O	O	O	-
	6 protezioni in plastica per codice 8-11100120.	8-11100126	-	O	O	O	-	O	O	O	O	-
	BPR Rullo premitallone con distanziale.	8-11400174	-	O	-	O	-	O	O	O	O	-

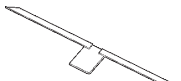
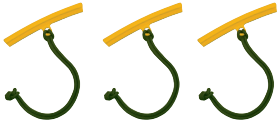

ACCESSORI PER SMONTAGOMME VETTURA TRADIZIONALI

Immagine	Descrizione	Codice	S 41 E	S 41 Maxi	S 41 E Maxi	S 42	S 42 E	S 43 - S 43Gp	S 45 Basic	S 45 - S 45Gp	S 45 TOP	S 44 M
CONSUMABILI												
	PTR Premitalone a rulli (standard con PT 40)	8-11400290	○	○	○	○	○	○	○	○	○	○
	SPL3 Serie di protezioni in plastica di ricambio per cerchi in lega (1 kit: 46 pezzi).	2201659	-	○	○	○	-	○	○	○	○	-
	MPK3 Serie di protezioni in plastica di ricambio per torretta.	8-11400096	-	●	●	●	-	●	●	●	●	-
	MPK4 Serie di protezioni in plastica di ricambio per TMN e TMN/CRU..	8-11400032	-	○	○	○	-	○	○	○	○	-
	MPK5 Serie di protezioni in plastica per torretta TAM.	8-11100369	-	○	○	○	-	○	○	○	○	○
	MPK6 Serie di protezioni in plastica per nuova testina scooter.	8-11100370	-	○	○	○	-	○	○	○	○	-
	CPK Serie di protezioni griffa di ricambio per cerchi in lega.	8-11400085	-	●	●	●	-	●	●	●	●	-
	CPK PLUS Serie di protezioni griffa con inserto in gomma per cerchi in lega.	8-11100358	-	○	○	○	-	○	○	○	○	-







ACCESSORI PER SMONTAGOMME VETTURA TRADIZIONALI

Immagine	Descrizione	Codice	S 41 E	S 41 Maxi	S 41 E Maxi	S 42	S 42 E	S 43 - S 43Gp	S 45 Basic	S 45 - S 45Gp	S 45 TOP	S 44 M
CONSUMABILI												
 x12	Kit di 12 protezioni per griffa , interno/esterno.	8-11100044	○	○	○	○	○	○	○	○	○	○
 x10	RGT "Reglette" in plastica per lo smontaggio dei pneumatici PAX SYSTEM.	801260235	○	○	○	○	○	○	○	○	○	○
	REP Kit singolo di 3 protezioni parabordo in plastica.	8-11120014	○	○	○	●	○	●	●	●	●	○
	REP 10 kit da 3 parabordi per cerchi in alluminio.	2201964	○	○	○	○	○	○	○	○	○	○
	REPS Serie di 3 protezioni parabordo corte in plastica.	8-11120015	○	○	○	○	○	○	○	○	○	○
	SVD Svitavalvole doppio - 1 pezzo.	2019932	○	○	○	○	○	○	○	○	○	○
	VP Tiravalvole - 1 pezzo.	2019933	○	○	○	○	○	○	○	○	○	○
	PTS Utensile in plastica.	4-405310A	○	○	○	○	○	○	○	○	○	○



ACCESSORI PER SMONTAGOMME VETTURA TRADIZIONALI

Immagine	Descrizione	Codice		S 41 E	S 41 Maxi	S 41 E Maxi	S 42	S 42 E	S 43 - S 43Gp	S 45 Basic	S 45 - S 45Gp	S 45 TOP	S 44 M
CONSUMABILI													
	PAR Protezione appoggio ruota.	8-11400289		-	O	O	O	-	O	O	O	O	-
	SGG Secchio porta grasso (4 Kg) con pennello.	8-11400034		O	O	O	O	O	O	O	O	O	O
	SG-WDK Secchio porta grasso (3,5 Kg) WDK.	3-00708		O	O	O	O	-	O	O	O	O	O



ACCESSORI PER SMONTAGOMME VETTURA TRADIZIONALI

Immagine	Descrizione	Codice	S 41 E	S 41 Maxi	S 41 E Maxi	S 42	S 42 E	S 43 - S 43Gp	S 45 Basic	S 45 - S 45Gp	S 45 TOP	S 44 M
MISCELLANEA												
	Dispositivo INDUSTRIA 4.0	8-15100033	-	-	-	-	O	O	O	O	O	-
	SR80 Sollevatore pneumatico. Capacità di sollevamento 80 kg. a 10 bar. Codice 8-11400223 solo per S48.	8-11400169	-	-	-	O	-	-	-	-	-	-
		8-11400170	-	-	-	-	O	-	-	-	-	-
		8-11400171	-	-	-	-	-	O	O	O	-	-
		8-11400223 (per S48)	-	-	-	-	-	-	-	-	-	-
	Kit RWL - Sollevatore Roller 70	8-11900276	O	O	O	O	O	O	O	O	-	O
	TPA-W kit torretta in plastica	8-11400329	-	O	O	O	-	O	O	O	O	O
	TPA-W kit torretta in plastica solo per S41E e S42E	8-11400334	O	-	-	-	O	-	-	-	-	-
	TPA-W torretta in plastica singola	8-11400330	-	O	O	O	-	O	O	O	O	O
	TMN Torretta per ruote scooter. Completa di protezioni in plastica per cerchi in lega.	8-11100378	-	O	O	O	-	O	O	O	O	O
	TMN Torretta per ruote scooter	801252083	O	-	-	-	O	-	-	-	-	-
	Kit cambio rapido torretta	8-11100001	O	-	-	-	O	-	-	-	-	-



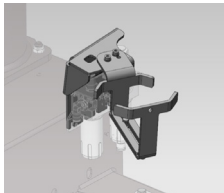
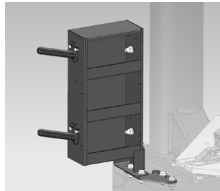

ACCESSORI PER SMONTAGOMME VETTURA TRADIZIONALI

Immagine	Descrizione	Codice		S 41 E	S 41 Maxi	S 41 E Maxi	S 42	S 42 E	S 43 - S 43Gp	S 45 Basic	S 45 - S 45Gp	S 45 TOP	S 44 M
MISCELLANEA													
	CRU Dispositivo universale per cambio rapido torretta (per S42/S43/S45/S45Basic).	8-11400197		-	-	-	O	-	O	O	O	O	-
	TPA/CRU Torretta in plastica completa (anche per S48).	8-11400088		-	-	-	O	-	O	-	O	-	-
	UL Utensile leva L=500 mm.	3009516		O	●	●	●	-	●	●	●	O	●
	LPK Serie di protezioni in plastica per leva UL.	8-11400098		O	●	●	●	-	●	●	●	O	●
	ULM Utensile leva per ruote moto L=400 mm.	3019000		O	O	O	O	-	O	O	O	O	O
	BPC Pinza premitallone in plastica.	801435685		O	O	O	O	O	O	O	O	O	O



ACCESSORI PER SMONTAGOMME VETTURA TRADIZIONALI

Immagine	Descrizione	Codice											
			S 41 E	S 41 Maxi	S 41 E Maxi	S 42	S 42 E	S 43 - S 43Gp	S 45 Basic	S 45 - S 45Gp	S 45 TOP	S 44 M	
MISCELLANEA													
	MPR Pinza premitallone in plastica per pneumatici RFT.	801262417	O	O	O	O	O	O	O	O	O	O	
	Morsetto basculante.	8-11100120	O	O	O	O	O	O	O	O	O	O	
	Stallonare moto per S 42 E	8-11120027	O	-	-	-	O	-	-	-	-	O	
	Kit supporto grasso regolabile 1-5 Kg	8-11120095	O	-	-	-	-	-	-	-	-	-	
	Kit cassetta accessori universale	8-11120092	O	-	-	-	O	-	-	-	-	-	

ACCESSORI PER SMONTAGOMME VETTURA TRADIZIONALI

Immagine	Descrizione	Codice		S 41 E	S 41 Maxi	S 41 E Maxi	S 42	S 42 E	S 43 - S 43Gp	S 45 Basic	S 45 - S 45Gp	S 45 TOP	S 44 M
COMPLEMENTARI													
	PO/ULGS Porta oggetti con manometro integrato e pedale gonfiaggio.	8-11400307		-	O	O	O	-	O	O	O	●	-
	IG.P pistola di gonfiaggio, omologata CE	8-11600126		O	-	-	-	O	-	-	-	-	O
	PGA/CE Pistoletta di gonfiaggio ASTURO (a norma CE - attac. baionetta) 10 bar.	8-11100342		-	-	-	O	-	O	O	O	-	-
	PGM/CE Pistoletta di gonfiaggio MICHELIN (a norma CE - baionetta)	8-11600187		-	-	-	O	-	O	O	O	-	-

ACCESSORI PER SMONTAGOMME VETTURA TRADIZIONALI

Immagine	Descrizione	Codice		S 41 E	S 41 Maxi	S 41 E Maxi	S 42	S 42 E	S 43 - S 43Gp	S 45 Basic	S 45 - S 45Gp	S 45 TOP	S 44 M
COMPLEMENTARI													
	GT40 Dispositivo di gonfiaggio rapido pneumatici tubeless da abbinare a FPI	8-11400240		-	O	O	O	-	O	O	O	O	-
	FPI Dispositivo di gonfiaggio con comando a pedale ed unità di lettura con pulsante di sgonfiaggio.	8-11400218		-	O	O	O	-	O	O	O	-	-

S 45 TL



07/012

Dotazione

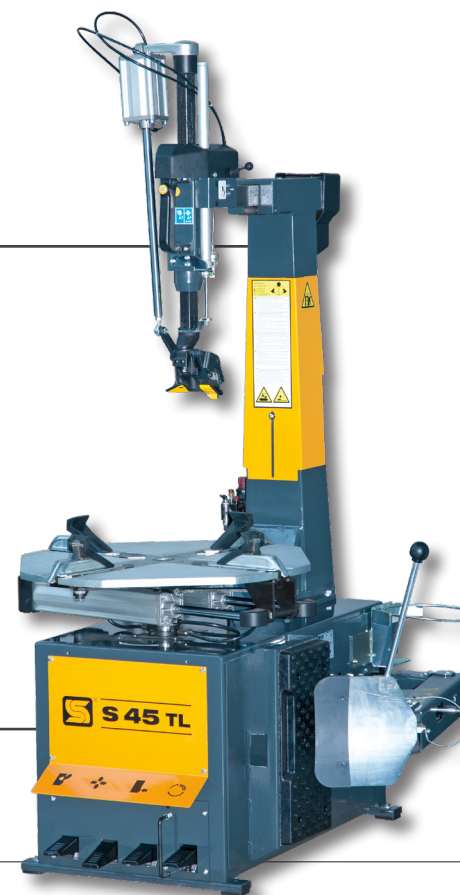
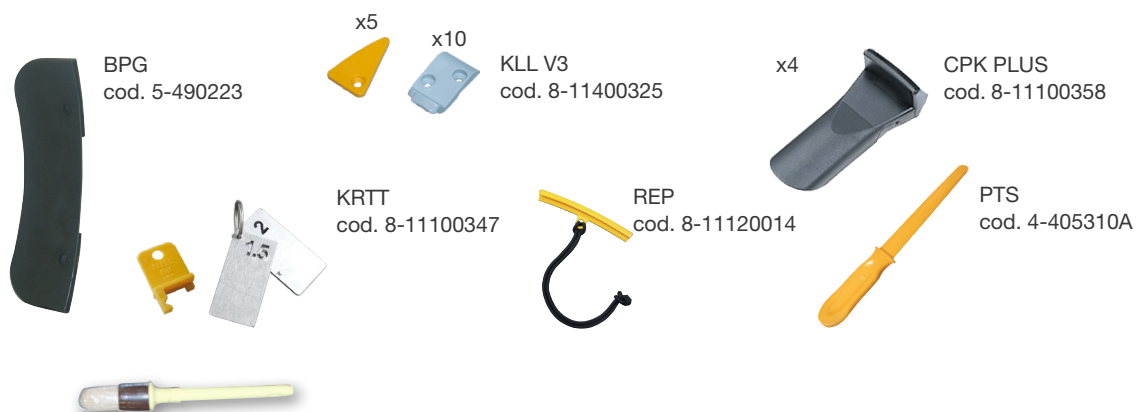

Codice	Alimentazione	Descrizione
0-11467001/AA	INV. 230V/1Ph/50-60Hz	S 45 TL RAL 1007
0-11467001/BA	INV. 230V/1Ph/50-60Hz	S 45 TL RAL 3002
0-11467001/CA	INV. 230V/1Ph/50-60Hz	S 45 TL RAL 5015
0-11467001/DA	INV. 230V/1Ph/50-60Hz	S 45 TL RAL 9006
0-11467101/AA	INV. 230V/1Ph/50-60Hz	S 45 TL GP RAL 1007 (PO/ULGS incluso)
0-11467101/BA	INV. 230V/1Ph/50-60Hz	S 45 TL GP RAL 3002 (PO/ULGS incluso)
0-11467101/CA	INV. 230V/1Ph/50-60Hz	S 45 TL GP RAL 5015 (PO/ULGS incluso)
0-11467101/DA	INV. 230V/1Ph/50-60Hz	S 45 TL GP RAL 9006 (PO/ULGS incluso)

S 45 TL TOP

Dotazione

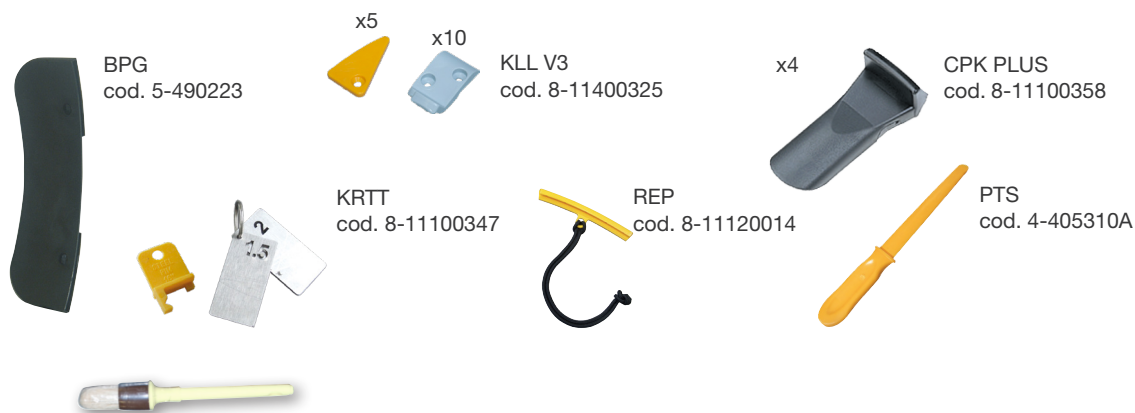

Codice	Alimentazione	Descrizione
0-11467003/AA	INV. 230V/1Ph/50-60Hz	S 45 TL TOP con BPT ribaltabile RAL 1007
0-11467003/BA	INV. 230V/1Ph/50-60Hz	S 45 TL TOP con BPT ribaltabile RAL 3002
0-11467003/CA	INV. 230V/1Ph/50-60Hz	S 45 TL TOP con BPT ribaltabile RAL 5015
0-11467003/DA	INV. 230V/1Ph/50-60Hz	S 45 TL TOP con BPT ribaltabile RAL 9006
0-11467102/AA	INV. 230V/1Ph/50-60Hz	S 45 TL TOP GP con BPT ribaltabile RAL 1007 (PO/ULGS incluso)
0-11467102/BA	INV. 230V/1Ph/50-60Hz	S 45 TL TOP GP con BPT ribaltabile RAL 3002 (PO/ULGS incluso)
0-11467102/CA	INV. 230V/1Ph/50-60Hz	S 45 TL TOP GP con BPT ribaltabile RAL 5015 (PO/ULGS incluso)
0-11467102/DA	INV. 230V/1Ph/50-60Hz	S 45 TL TOP GP con BPT ribaltabile RAL 9006 (PO/ULGS incluso)

S 48 TL TOP



07/008

Dotazione

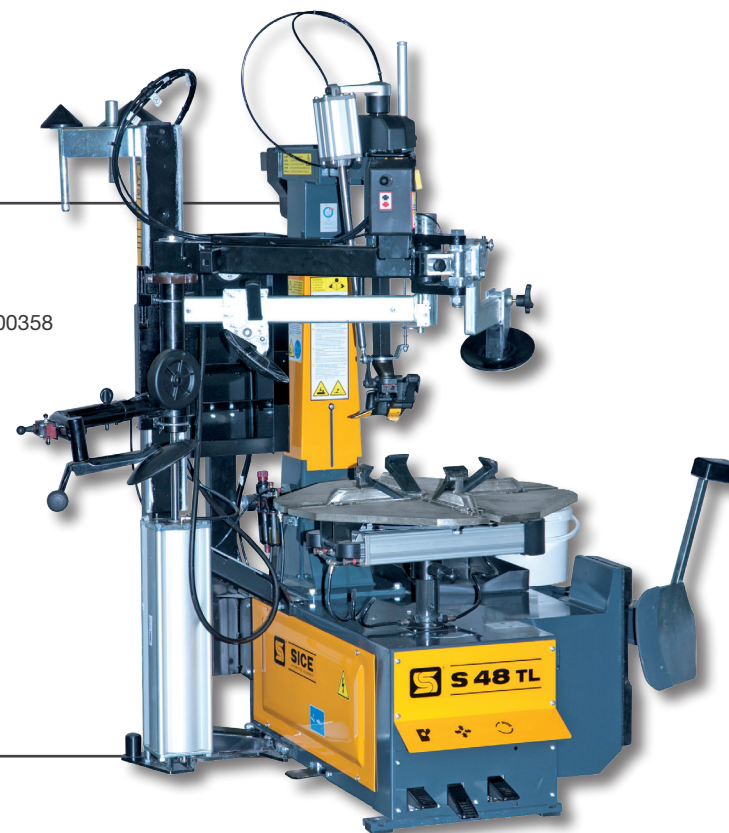
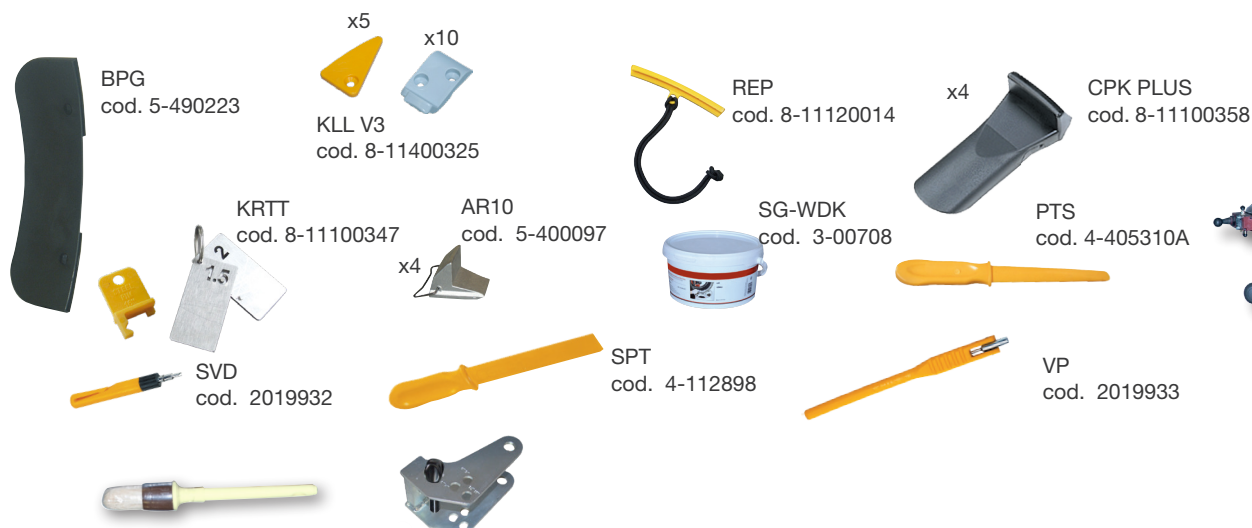

Codice	Alimentazione	Descrizione
0-11455017/AA	INV. 230V/1Ph/50-60Hz	S48 TL TOP Power-Out RAL1007
0-11455017/BA	INV. 230V/1Ph/50-60Hz	S48 TL TOP Power-Out RAL3002
0-11455017/CA	INV. 230V/1Ph/50-60Hz	S48 TL TOP Power-Out RAL5015
0-11455017/DA	INV. 230V/1Ph/50-60Hz	S48 TL TOP Power-Out RAL9006

S 200



07/016

Dotazione

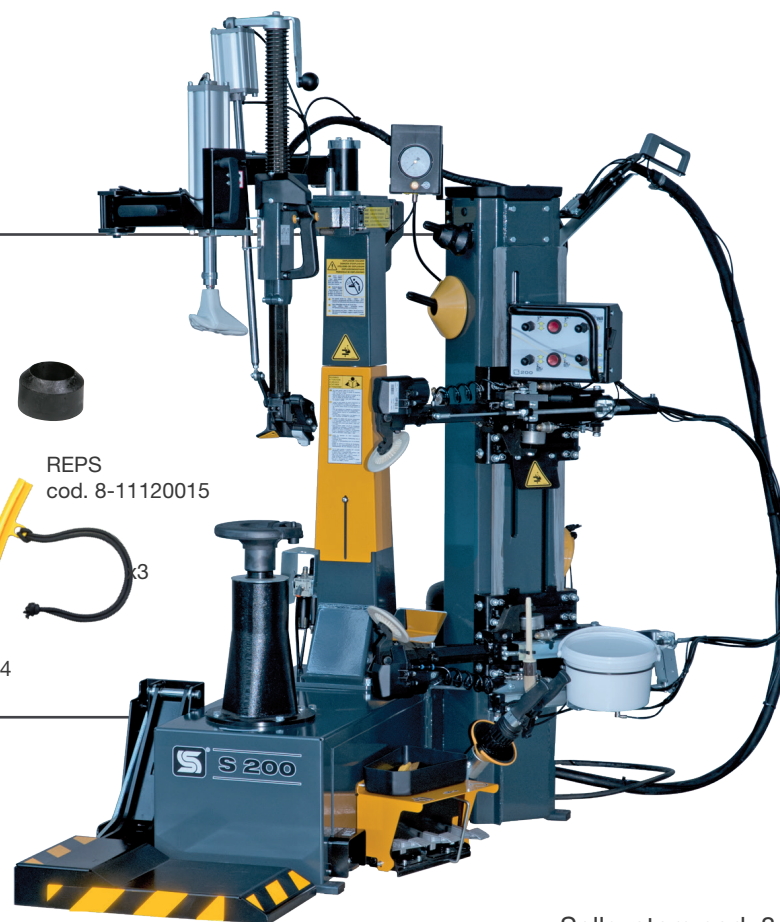

Sollevatore cod. 8-11100415 e
 Dispositivo di gonfiaggio GT70 cod.
 8-11100416 a richiesta

Codice	Alimentazione	Descrizione
0-11478002/40	INV. 230V/1Ph/50-60Hz	S 200
0-11478004/40	INV. 230V/1Ph/50-60Hz	S 200 con sollevatore

S 200 A



07/017

Dotazione

PTS
cod. 4-405310A



cod. 8-11400327



MPR
cod. 801262417



SVD
cod. 2019932



REPS
cod. 8-11120015

REP
cod. 8-11120014

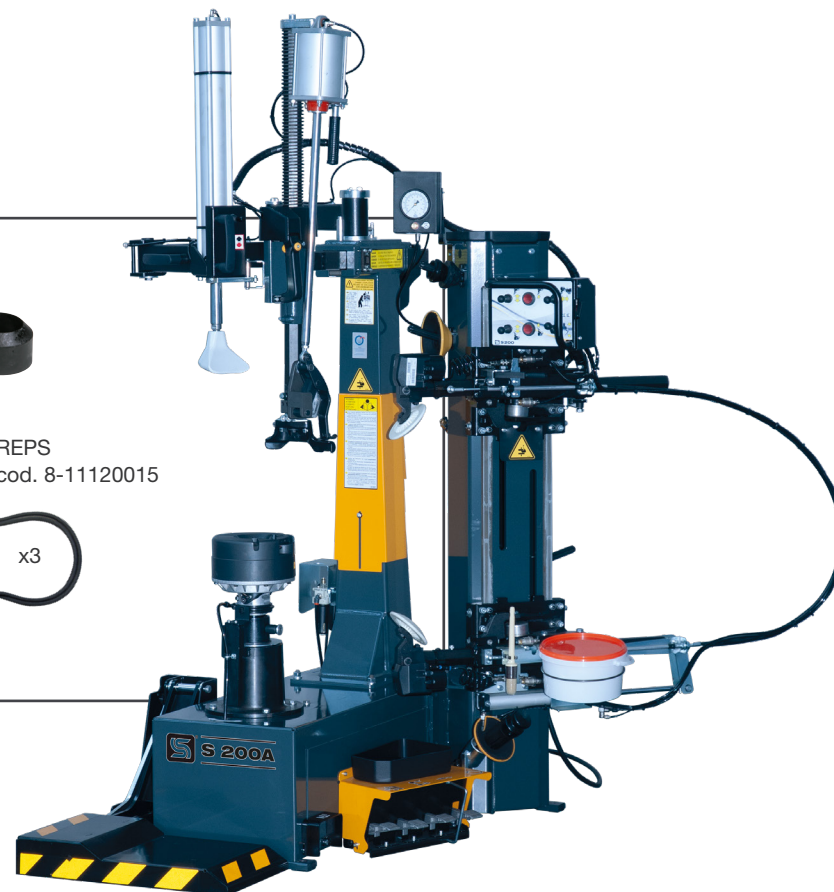

Sollevatore cod. 8-11100415 e Dispositivo di gonfiaggio GT70 cod. 8-11100416 a richiesta

Codice	Alimentazione	Descrizione
0-11478006/40	INV. 230V/1Ph/50-60Hz	S 200A
0-11478007/40	INV. 230V/1Ph/50-60Hz	S 200A con sollevatore

SERIE S 300



07/001

Dotazione



Codice	Alimentazione	Descrizione	
0-11465023/00	230V/1ph/50-60	S 300	
0-11465008	230V/1Ph/50-60Hz	S 300 BMW RAL 7016	

S 1000 EVOLUZIONE S.L.



07/015

Dotazione



Codice	Alimentazione	Descrizione	
0-11471001/40	200-230V/1Ph/50-60Hz	S 1000 EVOLUZIONE Base: con premitallone e sollevatore standard.	
0-11471002/40	200-230V/1Ph/50-60Hz	S 1000 EVOLUZIONE Visual: con premitallone, sollevatore standard e telecamera.	
0-11471004/40	200-230V/1Ph/50-60Hz	S 1000 EVOLUZIONE Plus: con premitallone, sollevatore standard, telecamera e inflatron.	

S 1000 EVOLUZIONE P.L.



07/015

Dotazione



Codice	Alimentazione	Descrizione	
0-11471006/40	200-230V/1Ph/50-60Hz	S 1000 EVOLUZIONE VISUAL P.L.: con premitallone, sollevatore Premium (sollevatore a movimento completo) e telecamera	
0-11471007/40	200-230V/1Ph/50-60Hz	S 1000 EVOLUZIONE PLUS P.L. : con premitallone, sollevatore Premium (sollevatore a movimento completo) , telecamera e Inflatron	

S 1000 EVOLUZIONE A P.L.

Dotazione

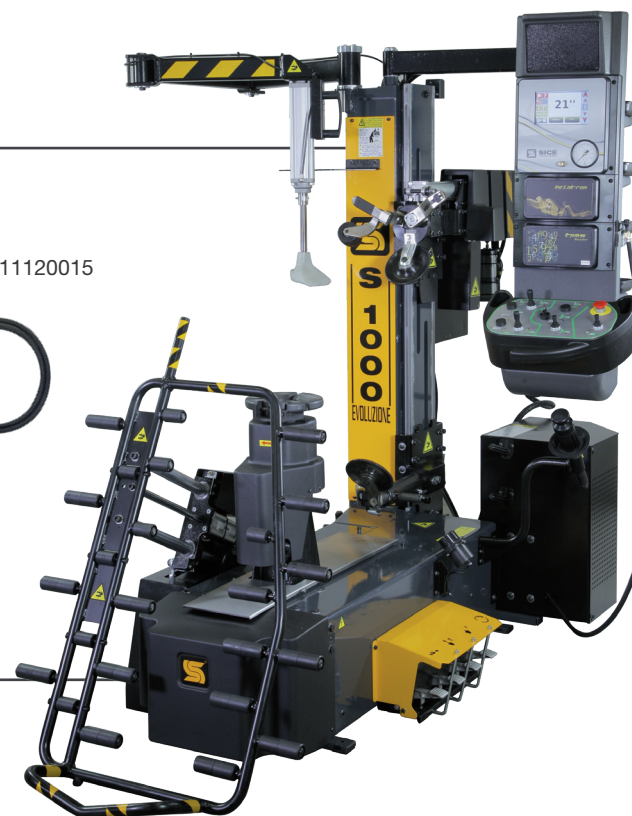





07/015



Codice	Alimentazione	Descrizione	
0-11471009/40	200-230V/1Ph/50-60Hz	S1000 versione BASE A P.L.: premitallone e sollevatore Premium (sollevatore a movimento completo), automatismo ciclo di smontaggio	
0-11471010/40	200-230V/1Ph/50-60Hz	S1000 versione VISUAL A P.L.: premitallone, sollevatore Premium (sollevatore a movimento completo), automatismo ciclo di smontaggio e telecamera	
0-11471008/40	200-230V/1Ph/50-60Hz	S 1000 EVOLUZIONE TOP A: con premitallone, sollevatore Premium (sollevatore a movimento completo), automatismo ciclo di smontaggio, telecamera, Inflatron, TPMS, lettore profondità battistrada e sonda temperatura	
0-11471011/64	200-230V/1Ph/50-60Hz	S1000 EVOLUZIONE TOP A BMW: con premitallone, sollevatore Premium (sollevatore a movimento completo), automatismo ciclo di smontaggio, telecamera, Inflatron, TPMS, lettore profondità battistrada e sonda temperature + Kit BMW	





ACCESSORI PER SMONTAGOMME VETTURA "LEVERLESS"

Immagine	Descrizione	Codice		S 45 TL	S 45 TL Top	S 48 TL Top	S 200	S 200 A	S 1000 - S 1000E	S 300	S 300 M
SISTEMA CONTROLLO SENSORI											
	TPM-02 Dispositivo portatile per il controllo dei sensori TPMS.	6015001300		O	O	O	O	O	O	O	O
	Kit OBD (cavo + card reader).	8-64500013		O	O	O	O	O	O	O	O
	TPM-02 PLUS (include kit OBD)	6015001391		O	O	O	O	O	O	O	O
	Abbonamento 12M TPM-02 standard	8-51100029									
	Abbonamento 12M TPM-02 extended	8-51120003									
	Abbonamento 12M TPM-02 PLUS	8-51120001		O	O	O	O	O	O	O	O
	Abbonamento 12M TPM-02 PLUS extended	8-51120004									
IMMAGINE NON DISPONIBILE	Servizio opzionale di installazione strumento.	8-51120006		O	O	O	O	O	O	O	O
	Stampante Bluetooth.	6015001360		O	O	O	O	O	O	O	O



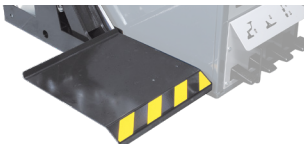

ACCESSORI PER SMONTAGOMME VETTURA "LEVERLESS"

Immagine	Descrizione	Codice		S 45 TL	S 45 TL Top	S 48 TL Top	S 200	S 200 A	S 1000 - S 1000E	S 300	S 300 M
SISTEMA PREMI TALLONE											
	PT250TL Dispositivo alza-premi tallone. Da installare in loco.	8-11100319		O	O	-	-	-	-	-	-
	PT250TL Dispositivo alza-premi tallone. Pre-installato in azienda.	8-11100320		O	●	-	-	-	-	-	-

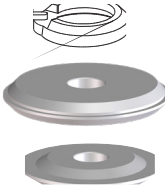

ACCESSORI PER SMONTAGOMME VETTURA "LEVERLESS"

Immagine	Descrizione	Codice		S 45 TL	S 45 TL Top	S 48 TL Top	S 200	S 200 A	S 1000 - S 1000E	S 300	S 300 M
ADATTATORI AUTOCENTRANTE											
 x4	AR10 Serie di adattatori per ridurre la capacità di bloccaggio esterno di 2".	8-11100043		-	-	●	-	-	-	-	-
 x4	AR24 Serie di adattatori per aumentare la capacità di bloccaggio esterno di 4".	8-11100041		O	O	O	-	-	-	-	-
 x4	AR69 Serie di adattatori per ridurre la capacità di bloccaggio esterno di 4".	8-11100042		O	O	O	-	-	-	-	-
SOLLEVATORI											
	SR300 Sollevatore pneumatico per ruote fino a 100 Kg.	8-11400178		-	-	-	-	-	-	O	O
	SR80 Sollevatore pneumatico. Capacità di sollevamento 80 kg. a 10 bar.	8-11400171		O	O	-	-	-	-	-	-
		8-11400223		-	-	O	-	-	-	-	-



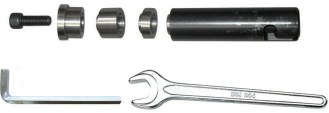

ACCESSORI PER SMONTAGOMME VETTURA "LEVERLESS"

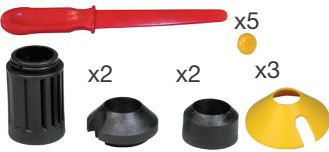
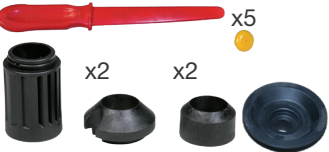
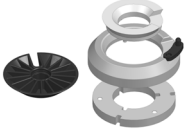
Immagine	Descrizione	Codice		S 45 TL	S 45 TL Top	S 48 TL Top	S 200	S 200 A	S 1000 - S 1000E	S 300	S 300 M
	Kit RWL - Sollevatore Roller 70	8-11900276		O	-	-	-	-	-	-	-
	SR80 PL Sollevatore pneumatico. Capacità di sollevamento 80 kg. a 10 bar.	8-11100316		-	-	-	-	-	-	-	-
	Sollevatore pneumatico per ruote fino a 85 Kg.	8-11100415		-	-	-	O	O	-	-	-
DISPOSITIVI DI BLOCCAGGIO											
	KCF Kit cerchi furgone.	8-11100361		-	-	-	-	-	-	O	O
	FRF Flangia universale per cerchi a canale rovescio. estensione perno = 120mm	8-11400209		-	-	-	-	-	-	O	O

ACCESSORI PER SMONTAGOMME VETTURA "LEVERLESS"

Immagine	Descrizione	Codice		S 45 TL	S 45 TL Top	S 48 TL Top	S 200	S 200 A	S 1000 - S 1000E	S 300	S 300 M
	Colonnette H120 mm (BMW)	8-11100448		-	-	-	-	-	-	O	O
	MFC Kit da usare con flangia FRF per cerchi con fori ciechi.	8-11400210		-	-	-	-	-	-	O	O
 x3	KP300 Kit di protezione cono.	8-11100297		-	-	-	-	-	-	●	●
 x3	KC300 Set di 3 coni di centraggio.	8-11100298		-	-	-	-	-	-	●	●
 x5 x2 x2 x3	Kit protezioni bloccaggio ruota	8-11100400		-	-	-	O	-	-	-	-
		8-11100401		-	-	-	-	O	-	-	-
 x5 x2 x2	Kit protezioni bloccaggio ruota	8-11100412		-	-	-	-	-	●	-	-
		8-11100460		-	-	-	-	O	O	-	-
	Kit cerchi larghi (h=+28 +22 mm) + cerchi furgone (bloccaggio automatico) Diam. foro centrale cerchio min 130, max 180 mm	8-11100460		-	-	-	-	O	O	-	-
	Kit cerchi larghi (h=+28 +22 mm) + cerchi furgone (bloccaggio manuale) Diam. foro centrale cerchio min 130, max 180 mm	8-11100417		-	-	-	O	-	-	-	-





ACCESSORI PER SMONTAGOMME VETTURA "LEVERLESS"

Immagine	Descrizione	Codice		S 45 TL	S 45 TL Top	S 48 TL Top	S 200	S 200 A	S 1000 - S 1000E	S 300	S 300 M
	FLANGIA UNIVERSALE ALL IN ONE H 100 MM + DISTANZIALI 20 MM	8-15100041	947,00	-	-	-	O	O	O	-	-
	FLANGIA UNIVERSALE "LARGE" H 100 mm + DISTANZIALI 20 mm (min-max interasse - PCD: 135-226 mm/53"-8.9")	8-15100049	967,00	-	-	-	O	O	O	-	-
	KIT PETALO LUNGO PER FLANGIA UNIVERSALE (6 pz) (min-max interasse - PCD: 135-226 mm/53"-8.9")	8-15100045	200,00	-	-	-	O	O	O	-	-
	KIT COLONNETTE 60 MM PER FLANGIA UNIVERSALE (6 pz) Colonnette H 60 mm/2.36"	8-15100044	209,00	-	-	-	O	O	O	-	-
	KIT PERNO BLOCCAGGIO MANUALE/ ELETTROMECCANICO PER FLANGIA UNIVERSALE Da montare sulla flangia universale con cerchi SENZA il foro centrale	8-15100042	88,00	-	-	-	O	O	O	-	-



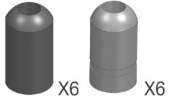

ACCESSORI PER SMONTAGOMME VETTURA "LEVERLESS"

Immagine	Descrizione	Codice		S 45 TL	S 45 TL Top	S 48 TL Top	S 200	S 200 A	S 1000 - S 1000E	S 300	S 300 M
NEW! 	KIT PERNO BLOCCAGGIO PNEUMATICO PER FLANGIA UNIVERSALE Da montare sulla flangia universale con cerchi SENZA il foro centrale	8-15100043	88,00					O			
NEW! 	MANIGLIA LUNGA BLOCCAGGIO MANUALE Da utilizzare con flangia universale per bloccare i cerchi tramite i fori bulloni	8-15100046	234,00				O				
NEW! 	MANIGLIA LUNGA BLOCCAGGIO PNEUMATICO Da utilizzare con flangia universale per bloccare i cerchi tramite i fori bulloni	8-15100047	234,00					O			
NEW! 	MANIGLIA LUNGA BLOCCAGGIO ELETTROMECCANICO Da utilizzare con flangia universale per bloccare i cerchi tramite i fori bulloni	8-15100048	280,00						O		
	PETALI STANDARD + COLONNETTE H 60 MM + DISTANZIALI H 20 MM	8-11100244		-	-	-	O	O	O	-	-
	PETALI STANDARD + COLONNETTE H 100 MM + DISTANZIALI H 20 MM	8-11100246		-	-	-	O	O	O	-	-





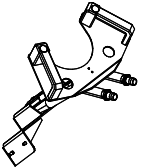

ACCESSORI PER SMONTAGOMME VETTURA "LEVERLESS"

Immagine	Descrizione	Codice		S 45 TL	S 45 TL Top	S 48 TL Top	S 200	S 200 A	S 1000 - S 1000E	S 300	S 300 M
	KEA28 Kit di 6 colonnette sferiche per cerchi AUDI.	8-11100291		-	-	-	O	O	O	-	-
	KPC12 Kit di 12 protezioni colonnette.	8-11100284		-	-	-	O	O	O	-	-
MISCELLANEA											
	GT300 gonfiatore tubeless.	8-11400179		-	-	-	-	-	-	O	O
	GT40 Dispositivo di gonfiaggio rapido pneumatici tubeless per S45 TL, S48 TL e S48 PL.	8-11400240		O	O	O	-	-	-	-	-
	GT70 Dispositivo di gonfiaggio per S 200	8-11100416		-	-	-	O	O	-	-	-







ACCESSORI PER SMONTAGOMME VETTURA "LEVERLESS"

Immagine	Descrizione	Codice		S 45 TL	S 45 TL Top	S 48 TL Top	S 200	S 200 A	S 1000 - S 1000E	S 300	S 300 M
	Dispositivo INDUSTRIA 4.0	8-15100032		-	-	-	O	O	-	-	-
	Dispositivo INDUSTRIA 4.0	8-15100034		-	-	-	-	-	O	-	-
	Dispositivo INDUSTRIA 4.0	8-15100012							O	-	-
	Dispositivo INDUSTRIA 4.0	8-15100033									
	MAT TC Porta accessori mobile	8-11100456		-	-	-	O	O	O	O	O
	Distanziale H=64mm per furgoni (Daily)	8-15100026		-	-	-	-	O	-	-	-
	T.I. kit sistema gonfiaggio rapido.	8-11100404		-	-	-	-	O	-	-	-
	PGA/CE Pistoletta di gonfiaggio ASTURO (a norma CE - attac. baionetta) 10 bar	8-11100342		O	-	-	-	-	-	-	-
	PGM/CE Pistoletta di gonfiaggio MICHELIN (a norma CE - baionetta)	8-11600187		O	-	-	-	-	-	-	-



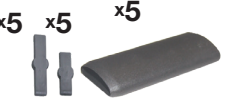

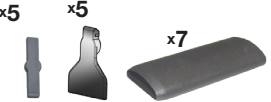



ACCESSORI PER SMONTAGOMME VETTURA "LEVERLESS"

Immagine	Descrizione	Codice		S 45 TL	S 45 TL Top	S 48 TL Top	S 200	S 200 A	S 1000 - S 1000E	S 300	S 300 M
	FPI Dispositivo di gonfiaggio con comando a pedale ed unità di lettura con pulsante di sgonfiaggio,	8-11400218		O	-	-	-	-	-	-	-
	MPR Pinza premitallone in plastica per pneumatici RFT.	801262417		O	O	O	●	●	●	O	O
	Morsetto basculante.	8-11100120		O	O	O	O	O	●	O	O
	KOF50 Distanziale supplementare per cerchi a canale rovescio.	8-11400181		-	-	-	-	-	-	●	●
	BPC Pinza premitallone in plastica.	801435685		O	O	O	O	O	O	O	O
	TPA-W torretta in plastica singola	8-11400327		-	-	-	-	O	-	-	-





ACCESSORI PER SMONTAGOMME VETTURA "LEVERLESS"

Immagini	Descrizione	Codice		S 45 TL	S 45 TL Top	S 48 TL Top	S 200	S 200 A	S 1000 - S 1000E	S 300	S 300 M
	KLL Kit di protezioni in plastica di ricambio per testina "leverless" (1 kit: 5+10 pcs).	8-11400293		●	●	●	-	-	-	-	-
	KLL V3 Kit di protezioni in plastica di ricambio per testina "leverless" V3 (1 kit: 5+10 pcs) valido da matricola IMA743101	8-11400325		●	●	●	●	-	-	-	-
	PTR Premi tallone a rulli (standard con PT 40).	8-11400290		O	O	O	-	-	-	-	-
	KPU Kit di protezioni in plastica di ricambio per il triplo-utensile. S 300 fino alla matricola IQB70317	8-11400212		-	-	-	-	-	O	O	
	KPUL Kit protezione utensile in plastica	8-11120035		-	-	-	-	O	O	O	
	TH kit protezione utensili. S 300 dalla matricola IQB780318	8-11120036		-	-	-	-	O	O	O	
	BPG Serie di protezioni in plastica grigiadi ricambio per nuova paletta stallonatrice, prodotta da ottobre 2004.	5-490223		●	●	●	-	-	-	-	-
	CPK Serie protezioni griffa di ricambio per cerchi in lega.	8-11400085		O	O	O	-	-	-	-	-

ACCESSORI PER SMONTAGOMME VETTURA "LEVERLESS"

Immagini	Descrizione	Codice		S 45 TL	S 45 TL Top	S 48 TL Top	S 200	S 200 A	S 1000 - S 1000E	S 300	S 300 M
CONSUMABILI											
 x8	CPK PLUS Serie protezioni griffa con inserto in gomma per cerchi in lega.	8-11100358		●	●	●	-	-	-	-	-
 x12	Kit di 12 protezioni per griffa , interno/esterno.	8-11100044		O	O	O	-	-	-	-	-
	REP Kit singolo di 3 protezioni parabordo in plastica. REP 10 kit da 3 parabordo singolo in plastica per cerchi in alluminio.	8-11120014 2201964		●	●	●	●	●	●	-	-
	REPS Serie di 3 protezioni corte parabordo in plastica.	8-11120015		-	-	-	●	●	●	●	●
	SVD Svitavalvole doppio.	2019932		O	O	●	●	●	O	●	●
	VP Tiravalvole.	2019933		O	O	●	O	O	O	●	●
	PTS Utensile in plastica.	4-405310A		●	●	●	●	●	●	●	●
	6 protezioni in plastica per codice 8-11100120.	8-11100126		O	O	O	O	O	O	O	O

ACCESSORI PER SMONTAGOMME VETTURA "LEVERLESS"

Immagini	Descrizione	Codice		S 45 TL	S 45 TL Top	S 48 TL Top	S 200	S 200 A	S 1000 - S 1000E	S 300	S 300 M
CONSUMABILI											
	PAR Protezione appoggio ruota.	8-11400289		O	O	O	-	-	-	-	-
	SGG Secchio porta grasso (4 Kg) con pennello.	8-11400034		O	O	O	O	O	O	O	O
	SG-WDK Secchio porta grasso (3 Kg) WDK.	3-00708		O	O	●	O	O	O	●	●
NEW!		Specchio rettangolare con supporto magnetico	8-11120117		-	-	-	O	O	O	O
	KPX 300 Kit per ruote Pax (per macchine da matricola IHA725054).	8-11120051		-	-	-	-	-	-	O	O

ACCESSORI PER SMONTAGOMME VETTURA "LEVERLESS"

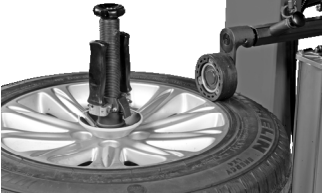
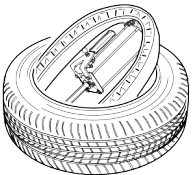
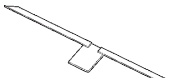
Immagini	Descrizione	Codice		S 45 TL	S 45 TL Top	S 48 TL Top	S 200	S 200 A	S 1000 - S 1000E	S 300	S 300 M
CONSUMABILI											
	Kit PAX System	8-11100338		-	-	-	O	O	-	-	-
	PAX PSR Estrattore Manuale	8-11100079		-	-	-	O	O	-	O	-
 x10	KRPS 30 Kit di 10 reglette per PAX System.	801260235		-	-	-	O	O	-	O	-

S 52 A

Dotazione



BBR
cod. 801289439



UB
cod. 801289440



PC
cod. 2192441



LA
cod. 801217615

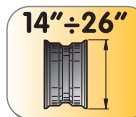
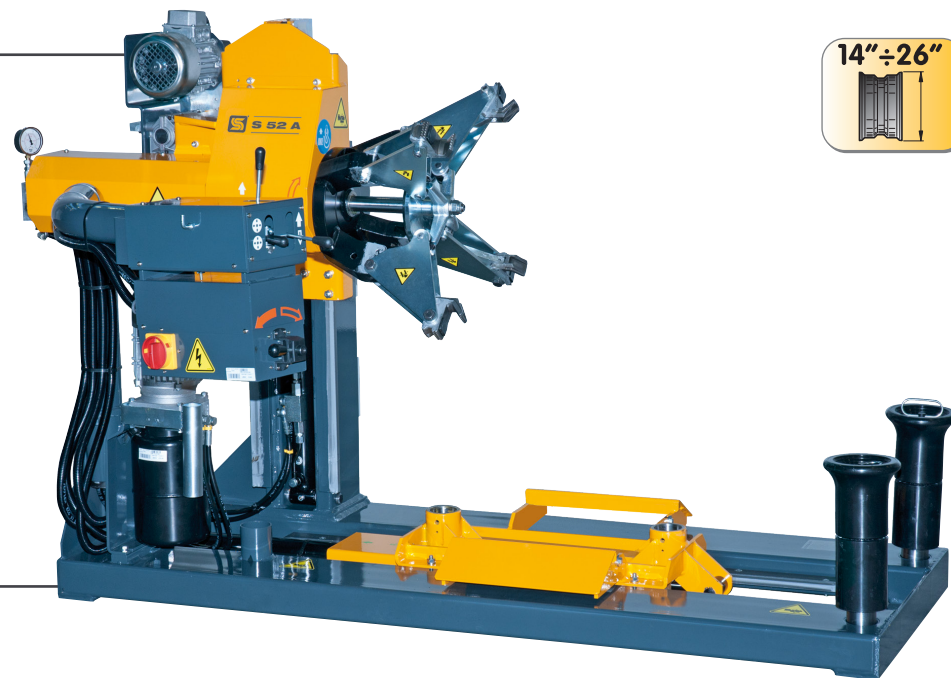

Codice	Alimentazione	Descrizione	
0-12447046/40	400V/3Ph/50Hz	S 52 A	
0-12447047/40	230V/3Ph/60Hz	S 52 A	
0-12447048/40	230V/1Ph/50Hz	S 52 A	

S 53

Dotazione



PC
cod. 219244I



LC
cod. 801417620



LA
cod. 801217615

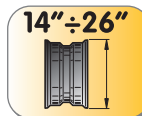
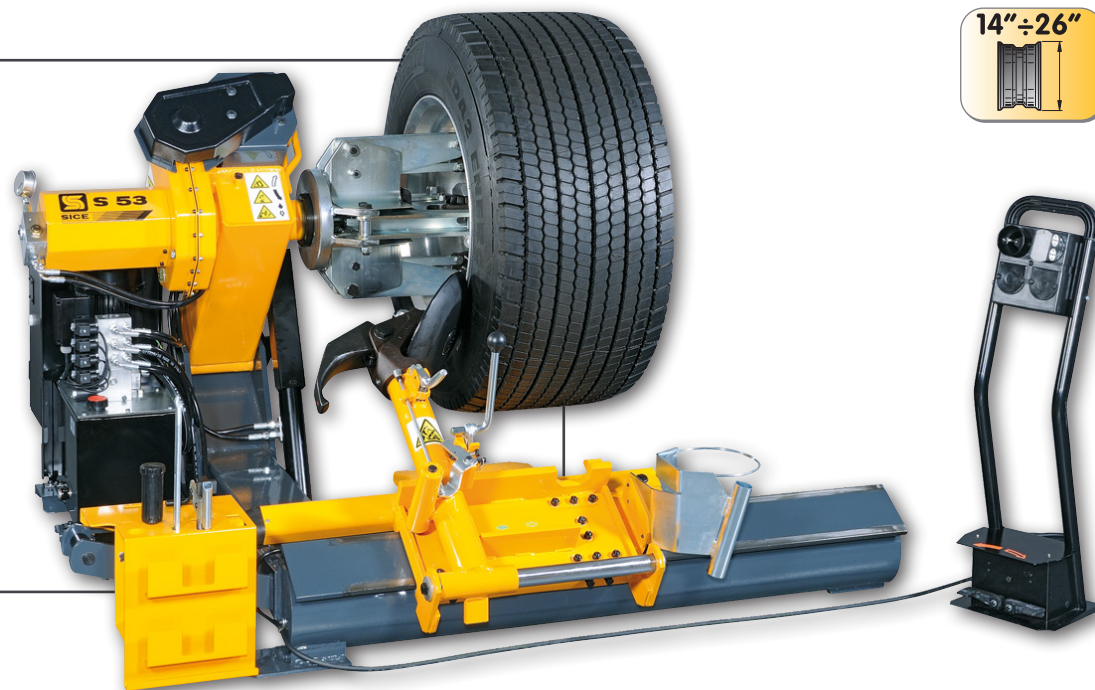

Codice	Alimentazione	Descrizione	
0-12423008/A	400V/3Ph/50Hz	S 53 RAL 1007	
0-12423008/B	400V/3Ph/50Hz	S 53 RAL 3002	
0-12423008/C	400V/3Ph/50Hz	S 53 RAL 5015	
0-12423009/A	230V/3Ph/50Hz	S 53 RAL 1007	
0-12423009/B	230V/3Ph/50Hz	S 53 RAL 3002	
0-12423009/C	230V/3Ph/50Hz	S 53 RAL 5015	
0-12423012/A	230V/1Ph/50Hz	S 53 RAL 1007	

S 54

Dotazione

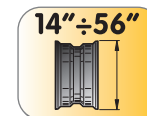

PC
cod. 219244I

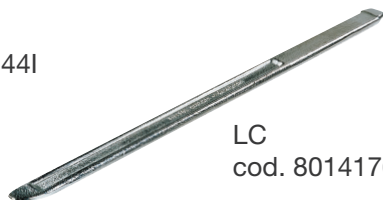

LC
cod. 801417620



LA
cod. 801217615



Codice	Alimentazione	Descrizione	
0-12400201/40	400V/3Ph/50Hz	S 54 RAL 1007	
0-12400204/40	230V/3Ph/50Hz	S 54 RAL 1007	

S 54 A

Dotazione

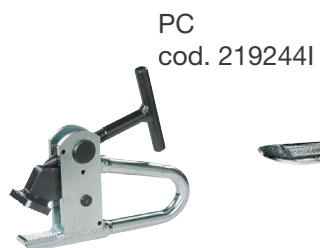

LC
cod. 801417620



LA
cod. 801217615

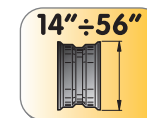

Codice	Alimentazione	Descrizione	
0-12400301/40	400V/3Ph/50Hz	S 54 A RAL 1007	
0-12400304/40	230V/3Ph/50Hz	S 54 A RAL 1007	

S 560 M

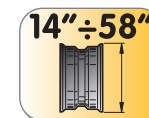

Dotazione



PC
cod. 219244I



LC
cod. 801417620



LA
cod. 801217615



Codice	Alimentazione	Descrizione	
0-12400501/40	400V/3Ph/50Hz	S 560 M RAL 1007	

S 55 - S 55A

Dotazione



PC
cod. 219244I



x4 KP56
cod. 8-12100046



LC
cod. 801417620



LA
cod. 801217615

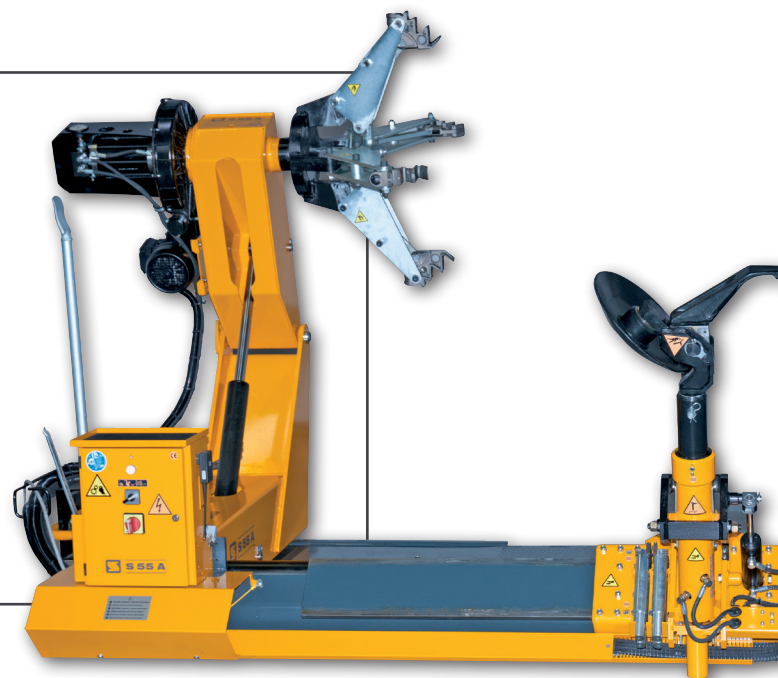

Codice	Alimentazione	Descrizione	
0-12449001/40	400V/3Ph/50Hz	S 55 CABLE	
0-12449002/40	230V/3Ph/50Hz	S 55 CABLE	
0-12450001/40	400V/3Ph/50Hz	S 55 ARM	
0-12450002/40	230V/3Ph/50Hz	S 55 ARM	
0-12451001/40	400V/3Ph/50Hz	S 55 A CABLE	
0-12451002/40	230V/3Ph/50Hz	S 55 A CABLE	
0-12452001/40	400V/3Ph/50Hz	S 55 A ARM	
0-12452002/40	230V/3Ph/50Hz	S 55 A ARM	

S 560 EVO



Dotazione



PC
cod. 219244I



LC
cod. 801417620



LA
cod. 801217615

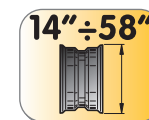

Codice	Alimentazione	Descrizione	
0-12440115/40	400V/3Ph/50Hz	S 560 EVO RAL 1007	
0-12440116/40	230V/3Ph/50Hz	S 560 EVO RAL 1007	

S 60

Dotazione



PC
cod. 2192441



LC
cod. 801417620



cod. 8-12100046 x 4



BBR
cod. 801289439



LA
cod. 801217615

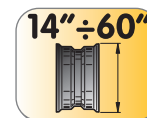

ECO MODE

Codice	Alimentazione	Descrizione	
0-12454001/40	400V/3Ph/50Hz	S 60 RAL 1007	

S 58LL

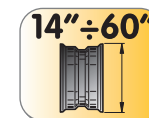

Dotazione



PC
cod. 2192441



LC
cod. 801417620



LA
cod. 801217615



Codice	Alimentazione	Descrizione	
0-12448001/40	400V/3Ph/50Hz	S 58 LL	

S 50A MOBILE

Dotazione



PC
cod. 219244I



cod. 36022258B



LC
cod. 801417620



LA
cod. 801217615



Codice	Alimentazione	Descrizione	
0-12456101/40	380V/3Ph/50Hz	S 50A Mobile , Installazione su furgoni, completo di generatore.	
0-12456001/40	380V/3Ph/50Hz	S 50A Mobile , Installazione su furgoni, senza generatore.	

S 50 MOBILE

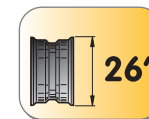







Dotazione







Codice	Alimentazione	Descrizione	
0-12101901/16	400V/3Ph/50Hz	S 50 Mobile , installazione su furgoni, completo di generatore	
0-12102201/16	400V/3Ph/50Hz	S 50 Mobile , installazione su furgoni, senza generatore	
8-12100042		Kit di personalizzazione	

ACCESSORI PER SMONTAGOMME CAMION

ACCESSORI PER SMONTAGOMME CAMION				S 52	S 52 A	S 53	S 54	S 54A	S 55 - S 55 A	S 60	S 560	S 560 EVO/ S560 M	S 58 LL	S 50 A MOBILE	S 50 MOBILE
Immagine	Descrizione	Codice													
DISPOSITIVO PREMI TALLONE															
	DP 12 Dispositivo premi tallone.	2201677		O	O	O	O	O	O	O	O	O	O	O	O
RULLI TUBELESS															
	RT Rullo tubeless per gomme da camion e autobus.	2306040C		-	-	O	O	O	-	-	-	-	-	-	-
	RT Rullo tubeless in acciaio.	19120014		-	-	-	-	-	O	-	-	-	-	-	-
	RT Rullo tubeless in plastica.	19120016		-	-	-	-	-	O	-	-	-	-	-	-
	RTB Rullo tubeless per gomme da camion e autobus.	801280918		-	-	-	-	-	-	-	O	O	-	-	-
	BBR Rullo stallonatore (anche per S 520).	801289439		●	●	-	-	-	-	●	-	-	-	-	-

ACCESSORI PER SMONTAGOMME CAMION

Immagine	Descrizione	Codice												
			S 52	S 52 A	S 53	S 54	S 54A	S 55 - S 55 A	S 60	S 560	S 560 EVO/ S 560 M	S 58 LL	S 50A MOBILE	S 50 MOBILE
PINZE E PERNI														
	PC Pinza per cerchi in ferro.	219244I	●	●	●	●	●	●	●	●	●	●	●	●
	PL Pinza per cerchi in lega.	801227195	○	○	○	○	○	○	○	○	○	○	○	○
	Morsetto di montaggio per ruote Skidder.	801251904	○	○	○	○	○	-	○	○	○	○	-	-
	MV Coppia di morsetti con vite per ruote con cerchietto.	801271597	○	○	○	○	○	○	○	○	○	●	-	-
	Perno di fermo per cerchi in lega.	801237171	○	○	○	○	○	○	○	○	○	○	○	○





ACCESSORI PER SMONTAGOMME CAMION

Immagine	Descrizione	Codice												
			S 52	S 52 A	S 53	S 54	S 54A	S 55 - S 55 A	S 60	S 560	S 560 EVO/ S 560 M	S 58 LL	S 50A MOBILE	S 50 MOBILE
ADATTATORI														
	ACL Adattatore cerchi in lega Ø 161 mm.	8-12100007	○	○	○	○	○	○	○	○	○	○	○	○
	ACL Adattatore cerchi in lega Ø 164 mm.	8-12100005	○	○	○	○	○	○	○	○	○	○	○	○
	ACL Adattatore cerchi in lega Ø 176 mm.	8-12100006	○	○	○	○	○	○	○	○	○	○	○	○
	ACL Adattatore cerchi in lega Ø 202 mm.	8-12100008	○	○	○	○	○	○	○	○	○	○	○	○
	ACL Adattatore cerchi in lega Ø 220 mm.	8-12300001	○	○	○	○	○	○	○	○	○	○	○	○
	ACL Adattatore cerchi in lega Ø 221 mm.	8-12100009	○	○	○	○	○	○	○	○	○	○	○	○
	ACL Adattatore cerchi in lega Ø 281 mm.	8-12100010	○	○	○	○	○	○	○	○	○	○	○	○

ACCESSORI PER SMONTAGOMME CAMION

Immagine	Descrizione	Codice												
			S 52	S 52 A	S 53	S 54	S 54A	S 55 - S 55 A	S 60	S 560	S 560 EVO/ S560M	S 58 LL	S 50A Mobile	S 50 Mobile
ACCESSORI PER GRIFFE														
	KGL56 Kit protezioni per cerchi in alluminio.	8-12100175	-	-	-	-	-	O	O	-	-	O	-	-
	PCL26 Set di 4 protezioni griffa per cerchi in lega, per S52A fino a matricola IRE303002K	801254494	O	O	-	-	-	-	-	-	-	-	O	-
	GL Griffe per cerchi in lega con speciali inserti in plastica (1 Set = 4 pz. + 12 inserti in plastica) - per S52A a partire da matricola numero IRE303002K	8-12100156	-	O	O	O	O	-	-	O	O	-	-	-
	SPI Inserti speciali in plastica di ricambio per GL.	8-11400200	-	-	O	O	O	-	-	O	O	-	-	-
	SPIG Inserti speciali in plastica di ricambio per griffe nuove.	8-12100172	-	-	O	O	O	-	-	O	O	-	-	-

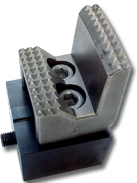

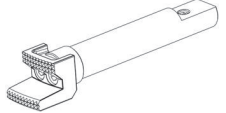
ACCESSORI PER SMONTAGOMME CAMION

Immagine	Descrizione	Codice		S 52	S 52 A	S 53	S 54	S 54A	S 55 - S 55 A	S 60	S 560	S 560 EVO/ S560M	S 58 LL	S 50A Mobile	S 50 Mobile
ACCESSORI PER GRIFFE															
 <p>x4</p>	P4P Prolunghe a 4 punte per cerchi con cerchietto.	8-12100171		-	-	-	-	-	O	O	-	-	O	-	-
	PA 4V Serie di 4 Prolunghe per autocentrante (fino a 56") (installabile su smontagomme prodotti dal 2012).	8-12100155		-	-	-	O	O	-	-	O	O	-	-	-
	PA26 Serie di 4 prolunghe per autocentrante : per aumentare la capacità fino a 28" , fino a matricola IRE303002K	8-12100176		-	O	-	-	-	-	-	-	-	-	O	-
 <p>x4</p>	KP56 Kit di 4 prolunghe 56".	8-12100046		-	-	-	-	-	●	●	-	-	-	-	-
	Kit prolunghe 60".	8-12300007		-	-	-	-	-	-	-	-	-	O	-	-



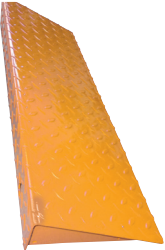
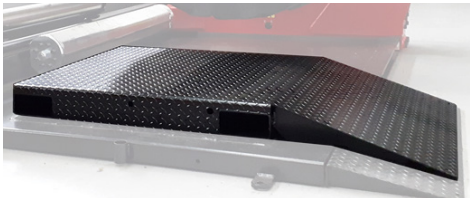

ACCESSORI PER SMONTAGOMME CAMION

Immagine	Descrizione	Codice		S 52	S 52 A	S 53	S 54	S 54A	S 55 - S 55 A	S 60	S 560	S 560 EVO/ S 560 M	S 58 LL	S 50A Mobile	S 50 Mobile
ACCESSORI VARI															
	Dispositivo INDUSTRIA 4.0	8-12120027		-	-	-	O	O	O	O	O	O	O	O	-
	CAR MATE per S 50A Mobile	8-12120008/90		-	-	-	-	-	-	-	-	-	-	O	-
	Rulliera per S 50A Mobile	8-12120011/90		-	-	-	-	-	-	-	-	-	-	O	-
	Prolunga per estensione soglia di carico H= 750 mm - S 50A Mobile	8-12120009		-	-	-	-	-	-	-	-	-	-	O	-
	Prolunga per estensione soglia di carico H= 1000 mm - S 50A Mobile	8-12120010		-	-	-	-	-	-	-	-	-	-	O	-

ACCESSORI PER SMONTAGOMME CAMION

ACCESSORI PER SMONTAGOMME CAMION				S 52	S 52 A	S 53	S 54	S 54A	S 55 - S 55 A	S 60	S 560	S 560 EVO/ S 560 M	S 58 LL	S 50A Mobile	S 50 Mobile
Immagine	Descrizione	Codice													
ACCESSORI VARI															
	Pedana carrello orizzontale.	8-12100039/40		-	O	-	-	-	-	-	-	-	-	-	-
	Pedana telaio laterale.	8-12100040/40		O	O	-	-	-	-	-	-	-	-	-	-
	Kit pedana H110	8-12120023/90		-	-	-	-	-	-	O	-	-	-	-	-
	Kit prolunghe cerchi gru portuali	8-12100188		-	-	-	-	-	O	O	-	-	O	-	-
	LC Leva per cerchietti.	801417620		O	O	●	●	●	●	●	●	●	●	●	●

ACCESSORI PER SMONTAGOMME CAMION

Immagine	Descrizione	Codice		S 52	S 52 A	S 53	S 54	S 54A	S 55 - S 55 A	S 60	S 560	S 560 EVO/ S 560 M	S 58 LL	S 50A Mobile	S 50 Mobile
ACCESSORI VARI															
	LA Leva alzatalone	801217615		●	●	●	●	●	●	●	●	●	●	●	●
	PE prolunga piattaforma (anche per S550) RAL7016.	801280917		-	-	-	-	-	-	O	O	-	-	-	-
	UB Utensile a becco per pneumatici con camera d'aria (anche per S520).	801289440		●	●	-	-	-	-	-	-	-	-	-	-
	BBD Disco stallonatore (anche per S520).	801289441		O	O	-	-	-	-	-	-	-	-	-	-





ACCESSORI PER SMONTAGOMME CAMION

			S 52	S 52 A	S 53	S 54	S 54A	S 55 - S 55 A	S 60	S 560	S 560 EVO/ S 560 M	S 58 LL	S 50A Mobile	S 50 Mobile
Immagine	Descrizione	Codice												
ACCESSORI VARI														
	GVA Ghiera bloccaggio ruota per smontagomme camion (anche per S520).	9239121	●	-	-	-	-	-	-	-	-	-	-	-
	GVA/R Ghiera bloccaggio rapido ruota per smontagomme camion (anche per S520).	802443938	○	-	-	-	-	-	-	-	-	-	-	-
x4 	Kit griffa Ø 80 mm.	8-12100037	-	-	-	-	-	○	-	-	-	○	-	-
x4 	Kit di 4 griffe e bielle, 4V.	8-12100157	-	-	○	-	-	-	-	-	-	-	-	-
x4 	Kit di 4 griffe e bielle, 4V.	8-12100158	-	-	-	○	○	-	-	-	-	-	-	-
	per S 560, S 545, S 550	8-12100160	-	-	-	-	-	-	-	○	○	-	-	-

ACCESSORI PER SMONTAGOMME CAMION

Immagine	Descrizione	Codice		S 52	S 52 A	S 53	S 54	S 54A	S 55 - S 55 A	S 60	S 560	S 560 EVO/ S 560 M	S 58 LL	S 50A Mobile	S 50 Mobile
ACCESSORI VARI															
	Kit Radiocomando Trolley 2,4 GHZ S/H per S 560 Dalla matricola IFN714717 fino alla matricola ITL819268	8-12400014		-	-	-	-	-	-	-	O	-	-	-	-
	SGP KIT radiocomando.	8-12100026		-	-	-	-	-	O	-	-	-	-	-	-
	Kit radio wireless	8-12120020		-	-	-	-	-	-	-	-	-	-	O	-
	Kit upgrade Radio per S50A Mobile indispensabile per smontagomme prodotti prima della matricola IPM182480	8-12120024		-	-	-	-	-	-	-	-	-	-	O	-

ACCESSORI PER SMONTAGOMME CAMION

Immagine	Descrizione	Codice													
			S 52	S 52 A	S 53	S 54	S 54A	S 55 - S 55 A	S 60	S 560	S 560 EVO/ S 560 M	S 58 LL	S 50A Mobile	S 50 Mobile	
ACCESSORI VARI															
	Kit Telecomando Radio	8-12120025/00	-	-	-	O	O	-	-	-	O	-	-	-	
	PLR Pennello.	4216498	O	O	O	O	O	O	O	O	O	O	O	O	
	SGG Vaso portagrasso con pennello (4 Kg).	8-11400034	O	O	O	O	O	O	O	O	O	O	O	O	
	Kit disco stallonatore per cerchietto	8-12100030	-	-	-	-	-	-	-	-	-	-	O	O	
	Kit Protezione Parabordo - 3 pz.	8-12100044	O	O	O	O	O	O	O	O	O	O	-	-	

